

GRID = 12" x 12"

T:\SolidWorks CAD\Work Standards\Grid Prints\BGSA\

PROPRIETARY AND CONFIDENTIAL
 THE INFORMATION CONTAINED IN THIS DRAWING IS THE
 SOLE PROPERTY OF INTECH TRAILERS. ANY REPRODUCTION
 IN PART OR AS A WHOLE WITHOUT THE WRITTEN PERMISSION
 OF INTECH TRAILERS IS PROHIBITED.

	NAME	DATE	<i>inTech Trailers</i> TEMPLATE WBGSA8.5x44TTA FLOORPLAN	
DRAWN	NJM	8/6/21		
CHECKED				
ENG APPR.				
ALL DIMENSIONS ARE IN INCHES AND ARE NOMINAL. DIMENSIONS ON ACTUAL TRAILER MAY VARY FROM WHAT IS SHOWN ON PRINT BASED ON ACTUAL FRAMING AND TRAILER STRUCTURE. UNLESS NOTED AS CRITICAL			DWG. NO. WBGSA8.5 TTA Trailer Assembly	REV. A
			SCALE: 1:60	SHEET 1 OF 4

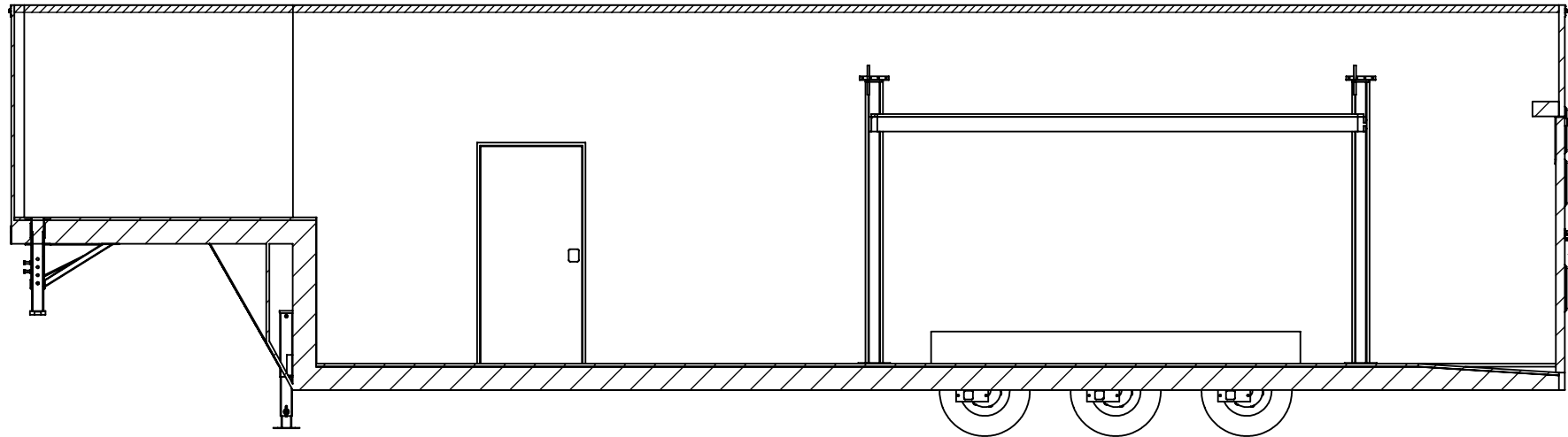

INTERIOR CURB SIDE

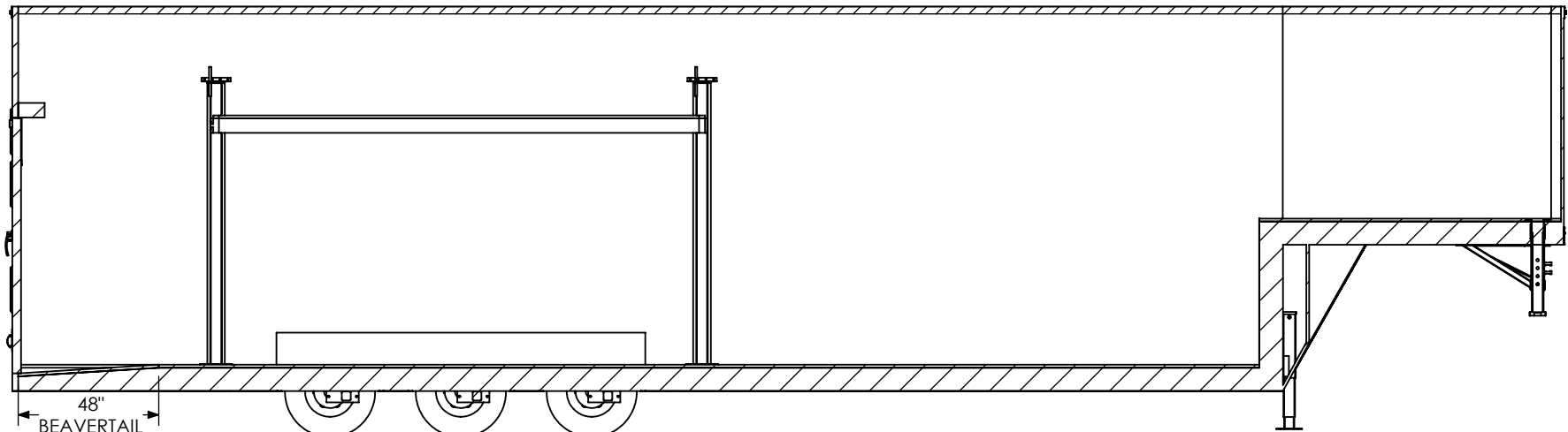

INTERIOR ROAD SIDE

48"
BEAVERTAIL

STANDARD:
- INTERIOR HEIGHT - 120"
- ENTRANCE DOOR - 36"

PROPRIETARY AND CONFIDENTIAL
THE INFORMATION CONTAINED IN THIS DRAWING IS THE SOLE PROPERTY OF INTECH TRAILERS. ANY REPRODUCTION IN PART OR AS A WHOLE WITHOUT THE WRITTEN PERMISSION OF INTECH TRAILERS IS PROHIBITED.

	NAME	DATE	inTech Trailers TEMPLATE WBGSA8.5x44TTA INTERIOR SIDES	
DRAWN	NJM	8/6/21		
CHECKED				
ENG APPR.				
ALL DIMENSIONS ARE IN INCHES AND ARE NOMINAL. DIMENSIONS ON ACTUAL TRAILER MAY VARY FROM WHAT IS SHOWN ON PRINT BASED ON ACTUAL FRAMING AND TRAILER STRUCTURE. UNLESS NOTED AS CRITICAL.			DWG. NO. WBGSA8.5 TTA Trailer Assembly	REV. A
			SCALE: 1:58	SHEET 2 OF 4

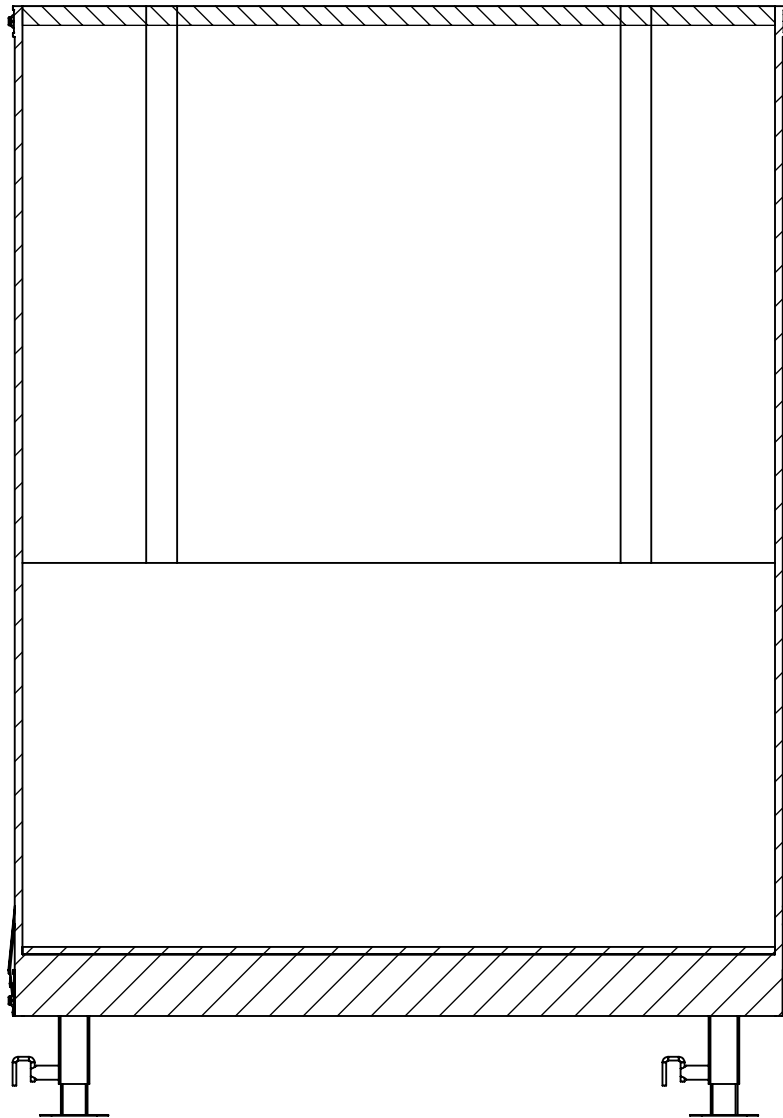

INTERIOR FRONT

	NAME	DATE	<i>inTech Trailers</i> TEMPLATE WBGSA8.5x44TTA INTERIOR FRONT	
DRAWN	NJM	8/6/21		
CHECKED				
ENG APPR.				
<p style="text-align: center;">PROPRIETARY AND CONFIDENTIAL</p> <p>THE INFORMATION CONTAINED IN THIS DRAWING IS THE SOLE PROPERTY OF INTECH TRAILERS. ANY REPRODUCTION IN PART OR AS A WHOLE WITHOUT THE WRITTEN PERMISSION OF INTECH TRAILERS IS PROHIBITED.</p>			<p>DWG. NO. WBGSA8.5 TTA Trailer Assembly</p>	
			<p>SCALE: 1:25</p>	
			SHEET 3 OF 4	

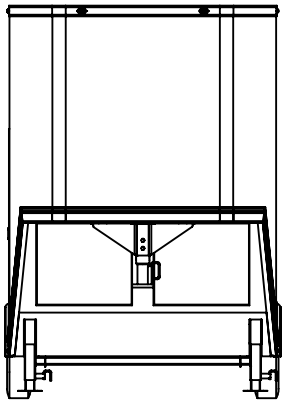

EXTERIOR FRONT

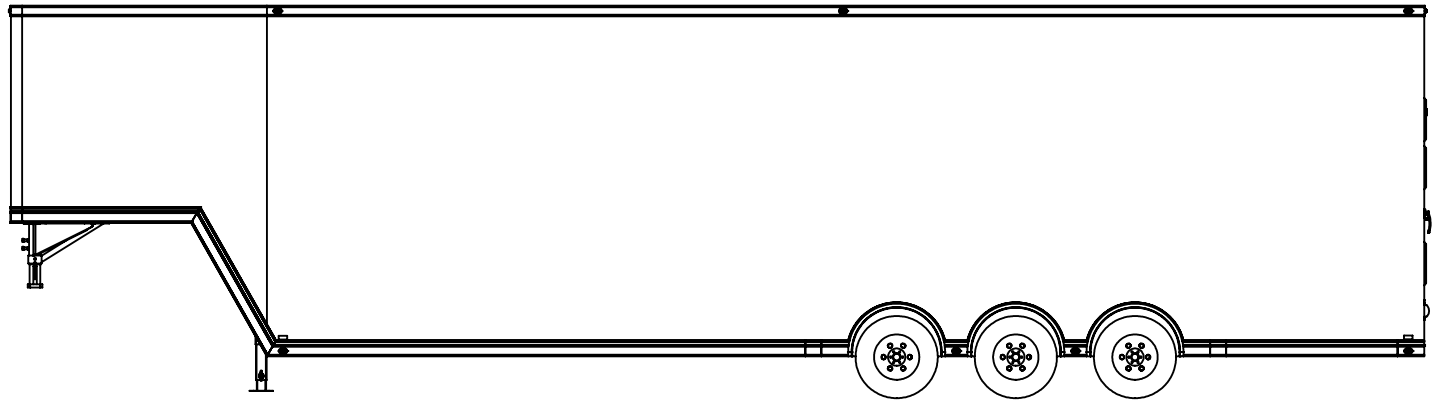

EXTERIOR ROAD SIDE

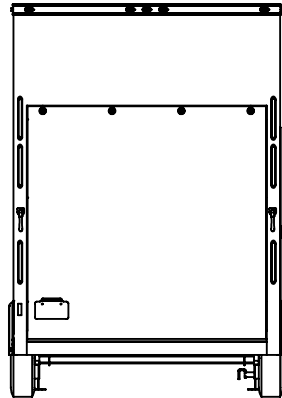

EXTERIOR REAR
RAMP DOOR STANDARD SIZE 90"W x 84"H

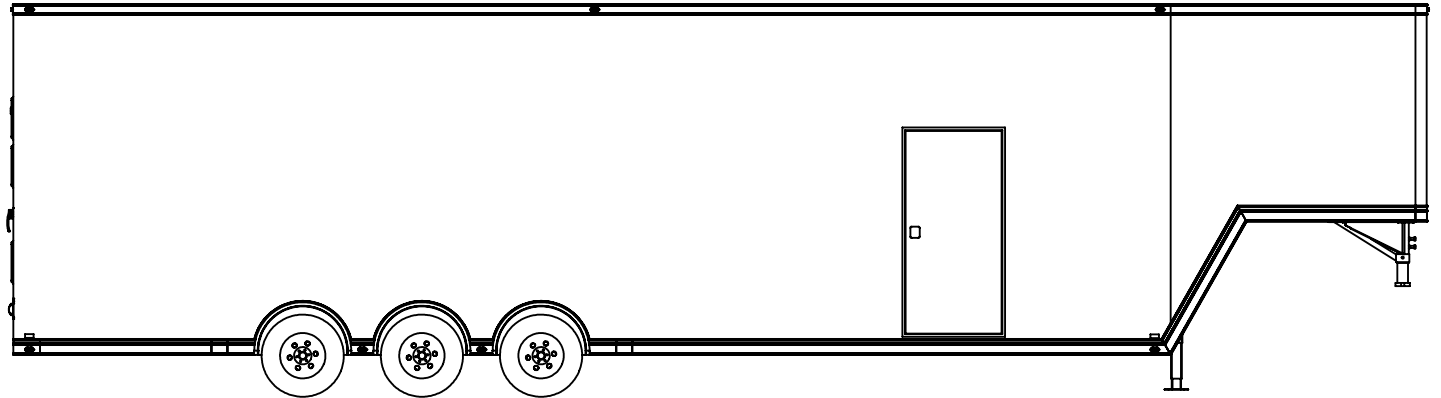

EXTERIOR CURB SIDE

	NAME	DATE	inTech Trailers TEMPLATE WBGSA8.5x44TTA EXTERIOR SIDES		
DRAWN	NJM	8/6/21			
CHECKED					
ENG APPR.					
ALL DIMENSIONS ARE IN INCHES AND ARE NOMINAL. DIMENSIONS ON ACTUAL TRAILER MAY VARY FROM WHAT IS SHOWN ON PRINT BASED ON ACTUAL FRAMING AND TRAILER STRUCTURE. UNLESS NOTED AS CRITICAL			DWG. NO.	REV.	
			WBGSA8.5 TTA Trailer Assembly		A
			SCALE: 1:72	SHEET 4 OF 4	

PROPRIETARY AND CONFIDENTIAL
THE INFORMATION CONTAINED IN THIS DRAWING IS THE SOLE PROPERTY OF INTECH TRAILERS. ANY REPRODUCTION IN PART OR AS A WHOLE WITHOUT THE WRITTEN PERMISSION OF INTECH TRAILERS IS PROHIBITED.